

coaxial valve

type FCF-K 80

5-FCF-K 80

valve type with pilot valve



2/2 way valve externally controlled
pressure range PN 0-40 bar
orifice DN 80 mm
connection flange
function valve normally closed
symbol NC

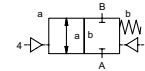

 Above stated body materials refer to the valve port connections that get in contact with the media only!

design pressure balanced, with spring return
body materials ① aluminium ②
 ③ ⑤
 ④ ⑥

valve seat synthetic resin on metal
seal materials NBR, PU PTFE, FPM, PE

details needed for main valve

- orifice
- port
- function NC
- operating pressure
- flow rate
- media
- media temperature
- ambient temperature
- type of actuation

details needed for pneumatic actuation

- nominal voltage
- type of protection
- actuation pressure range min/max
- pilot valve type

details needed for hydraulic actuation

- actuation pressure range min/max
- hydraulic control valve function

 The valves' technical design is based on media and application requirements. This can lead to deviations from the general specifications shown on the data sheet with regards to the design, sealing materials and characteristics.

 If order or application specifications are incomplete or imprecise there exists a risk of an incorrect technical design of the valve for the required application. As a consequence, the physical and / or chemical properties of the materials or seals used, may not be suitable for the intended application.

■ specifications not highlighted are standard
 ■ specifications highlighted in grey are optional

general specifications

ports	FCF-K	flanges PN 16/40
function	NC	
pressure range	bar 0-16/0-40	
Kv value	m ³ /h	122,0
vacuum	leak rate < 10 ⁻⁴ mbar·l·s ⁻¹	
pressure-vacuum	P ₁ ⇔ P ₂	pressure side max. 40 bar vacuum side leak rate < 10 ⁻⁴ mbar·l·s ⁻¹
back pressure	P ₂ > P ₁	available (max. 16 bar)
media	emulsions - oils - neutral gases other medias upon request	
abrasive media		
damping	opening	
	closing	by throttles on pilot valve
flow direction	A ⇔ B	as marked bi-directional upon request (max. 16 bar)
switching cycles	1/min	50
switching time	ms	opening 350-3000 closing 350-3000
media temperature	°C	direct mounted pilot valve 60 >60°C upon request
ambient temperature	°C	direct mounted pilot valve 50 >50°C upon request
flush ports		
leak ports		
limit switches		
manual override	via pilot valve	
approvals	upon request	
mounting		
weight	kg	FCF-K 11,5
additional equipment	sensor / manometer connection G 1/4	

options

electrical specifications

nominal voltage	U _n	DC 24V	special voltage upon request
	U _n	AC 230V 50 Hz	special voltage upon request
power consumption	DC	4,8 W	
	AC	pick up 11,0 VA holding 8,5 VA	
protection	IP 65 (P54)	acc. DIN 40 050	
energized duty rating	ED	100%	
connection		plug acc. DIN EN 175301-803 form B, 4 positions x 90° / wire diameter 6-8 mm	
additional equipment		illuminated plug with varistor	
optional	M12x1	connector acc. DESINA	connector acc. VDMA
max. temperature	media	60°C	
	ambient	50°C	
explosion proof	EEx m II T5	nominal voltage U _n	direct current 24 V 3,25 W
		power consumption	alternating current 230 V 50 Hz 2,90 W

options

pneumatic specifications

actuation pressure range	bar	4-10	3-10 upon request
air consumption	cm ³ /stroke	100	
cycle speed	main valve speed variable by throttles on pilot valve		
control	preferably 5/2-way pilot valve		
pilot valve interface	NAMUR VDI / VDE 3845		ISO 1 DIN 5599/1
actuator ports	2/4	G 1/4	G 3/8

options

hydraulic specifications

actuation pressure range	bar	30-60
by media	preferably 4/2-way control valve	
control	X/Y	G 1/4
actuator ports		NPT 1/4

options

type FCF-K 80

function: **NC**
closed when not energized

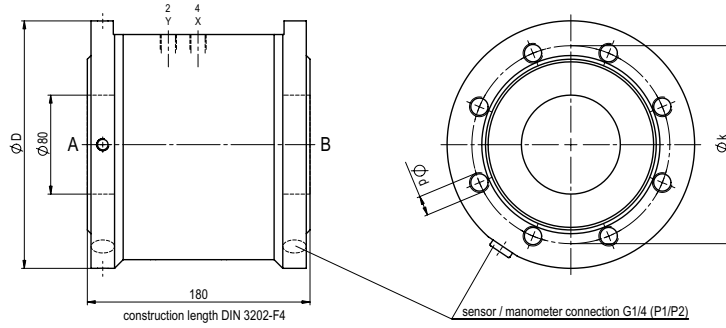

flanges PN	DIN	øD	øk	ød
16	2633	200	160	M16
40	2635	200	160	M16

pneumatic actuation (separately)

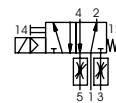

5/2-way-pilot valve
flow rate 700 l/min
pressure range 3-10 bar G 1/8

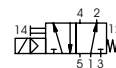

5/2-way-pilot valve ISO 1
flow rate 700 l/min
pressure range 3-10 bar G 1/4

The application-specific layout relating to temperature, pressure conditions, switching behavior, media and its consistency may restrict the range of use or necessitate relevant modifications to materials used and seal arrangements.

Rights reserved to make technical alterations • Not responsible for printing errors • Detailed drawings can be obtained upon request