

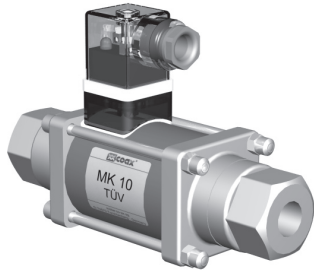

coaxial valve

type MK 10 TÜV

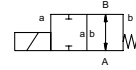
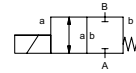

2/2 way valve direct acting
pressure range PN 0-40 bar
orifice DN 10 mm
connection thread
function valve normally closed symbol **NC**
 valve normally open symbol **NO**



 Above stated body materials refer to the valve port connections that get in contact with the media only!

design pressure balanced, with spring return
body materials  TÜV

valve seat synthetic resin on metal
seal materials FPM, PTFE

details needed

- orifice
- port
- function NC/NO
- operating pressure
- flow rate
- media
- media temperature
- ambient temperature
- nominal voltage

general specifications

options

ports	MK	threads G 1/4 - G 3/4	
function		NC	NO
pressure range	bar	0-40	
Kv value	m³/h	2,5	
vacuum	leak rate		
pressure-vacuum	P1 ↔ P2		
back pressure	P2 > P1		available (max. 16 bar)
media		liquid fuels	
abrasive media			
damping	opening		
	closing		
flow direction	A ↔ B	as marked	
switching cycles	1/min	200	
switching time	ms	opening 25 closing 25	
media temperature	°C	DC: -10 to +140	
		AC: -10 to +140	
ambient temperature	°C	DC: -10 to +60	
		AC: -10 to +60	
limit switches			
manual override			
approvals	TÜV	DIN EN 264 + E DIN 32725	
mounting			mounting brackets
weight	kg	MK 1,5	
additional equipment			

electrical specifications

options

nominal voltage	U _n	24 V	DC
	U _n	230 V 40-60 Hz	AC
actuation	DC	direct-current magnet	
	AC	direct-current magnet with integrated rectifier	
insulation rating	H	180°C	
protection	IP65		
energized duty rating	ED	100%	
connection		plug acc. DIN EN 175301-803 form A, 4 positions x 90° / wire diameter 6-8 mm	
optional additional equipment			
current consumption	N-coil		
	H-coil	24 V	DC 1,29 A
		230 V 40-60 Hz	AC 0,16 A
explosion proof			
limit switches			

 The valves' technical design is based on media and application requirements. This can lead to deviations from the general specifications shown on the data sheet with regards to the design, sealing materials and characteristics.

 If order or application specifications are incomplete or imprecise there exists a risk of an incorrect technical design of the valve for the required application. As a consequence, the physical and / or chemical properties of the materials or seals used, may not be suitable for the intended application.

■ specifications not highlighted are standard
 ■ specifications highlighted in grey are optional

type **MK 10 TÜV**

function: **NC**
closed when not energized

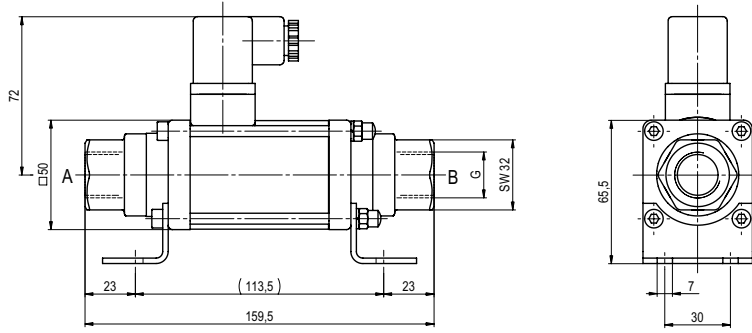

type **MK 10 TÜV**

function: **NO**
open when not energized

